

FERMATOR

KONZOLE PRO UPEVNĚNÍ ŠACHETNÍCH DVEŘÍ

KONZOLE PRO UPEVNĚNÍ ŠACHETNÍCH DVEŘÍ FERMATOR

- ZESÍLENÉ KONZOLE TYP "A"

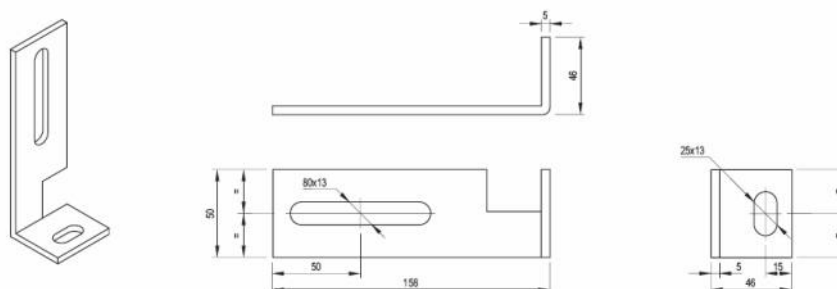

- ZESÍLENÉ KONZOLE TYP "D"

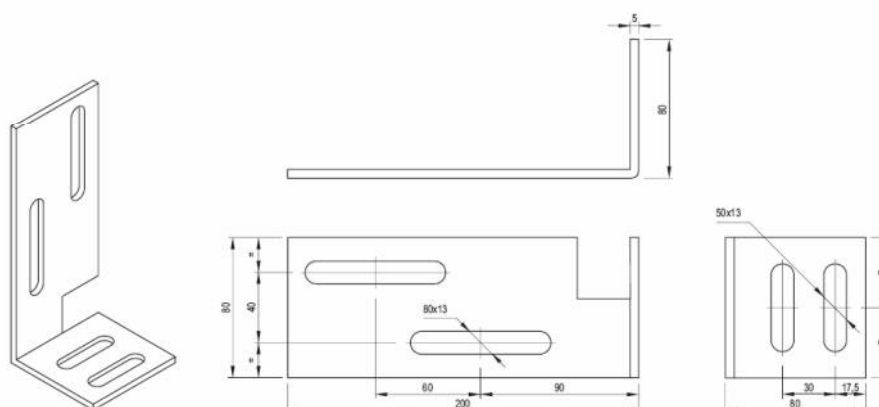

- KONZOLE TYP "E"

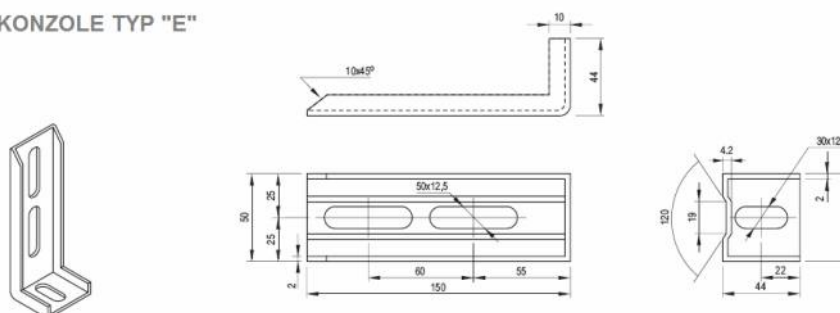

FERMATOR

KONZOLE PRO UPEVNĚNÍ ŠACHETNÍCH DVEŘÍ

KONZOLE PRO UPEVNĚNÍ ŠACHETNÍCH DVEŘÍ FERMATOR

• KONZOLE TYP "F"

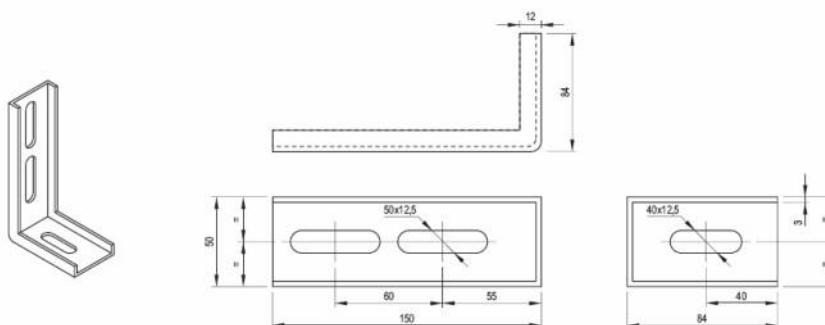

• KONZOLE TYP "G"

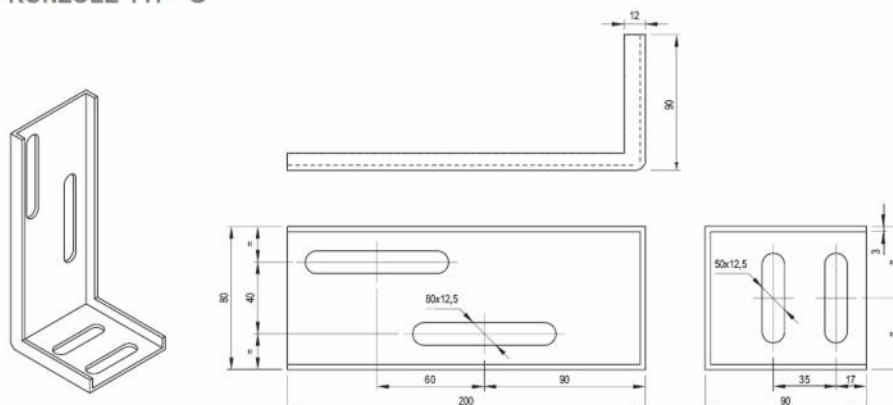

• KONZOLE TYP "H"

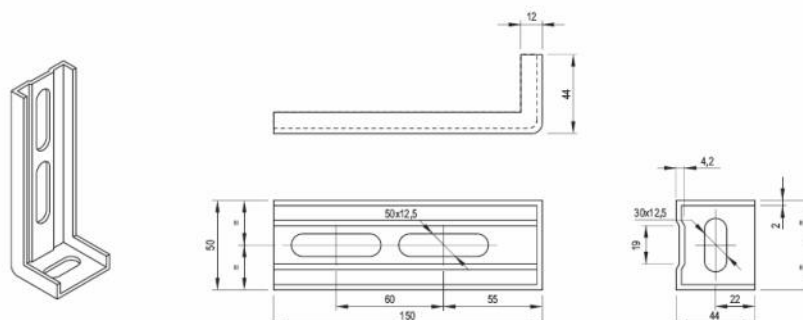

FERMATOR

KONZOLE PRO UPEVNĚNÍ ŠACHETNÍCH DVEŘÍ

KONZOLE PRO UPEVNĚNÍ ŠACHETNÍCH DVEŘÍ FERMATOR

• KONZOLE TYP "V8"

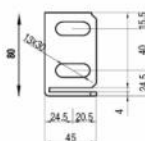
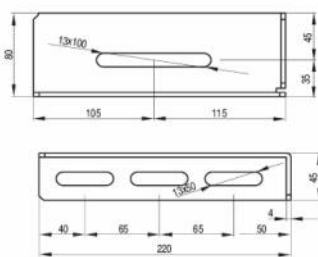
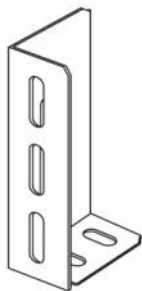

Pohled na montáž konzole "V8"
Přesah prahu do šachty větší než 80mm.

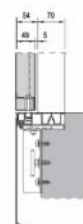

• KONZOLE TYP "V2"

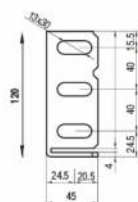
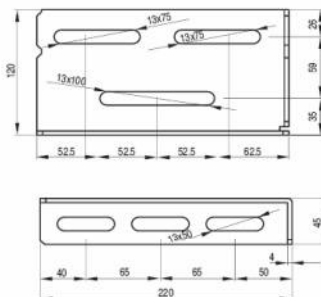
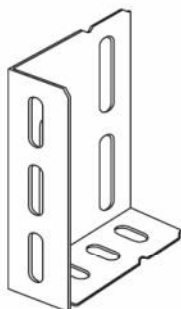

Pohled na montáž konzole "V2"
Přesah prahu do šachty větší než 120mm.



• KONZOLE TYP "V7"

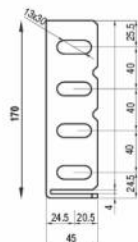
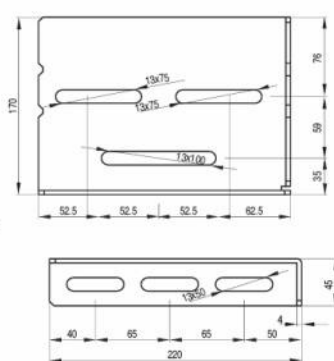
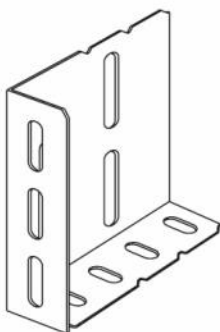

Pohled na montáž konzole "V7"
Přesah prahu do šachty větší než 170mm.

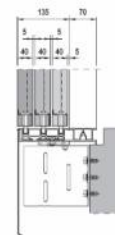

• CELOPRAHOVÁ MONTÁŽNÍ KONZOLE

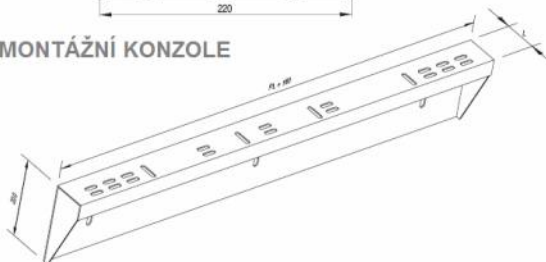

L
50
80
130
190

FERMATOR

KONZOLE PRO UPEVNĚNÍ ŠACHETNÍCH DVEŘÍ

KONZOLE PRO UPEVNĚNÍ ŠACHETNÍCH DVEŘÍ FERMATOR
POUŽITÍ KONZOLÍ PRO RŮZNÉ TYPY ŠACHETNÍCH DVEŘÍ

2PC a 1PT

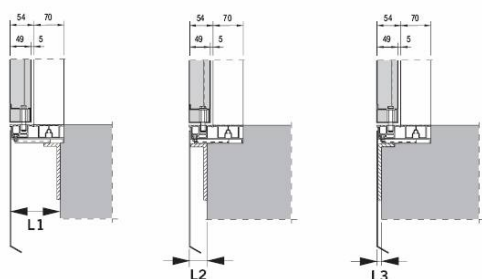

KONZOLE	ZPŮSOB UPEVNĚNÍ V ŠACHTĚ		
	L1	L2	L3
A	95	46	15
D	120	80	15
H	95	44	---
G	120	90	---
V8	130	80	---
V2	170	120	---
V7	220	170	---

4PC a 2PT

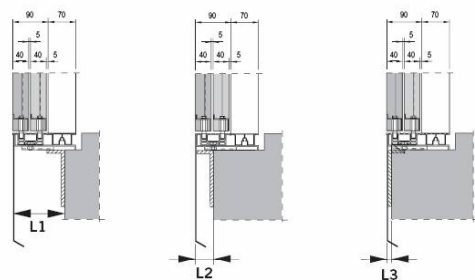

KONZOLE	ZPŮSOB UPEVNĚNÍ V ŠACHTĚ		
	L1	L2	L3
A	95	46	15
D	130	89	15
G	140	90	---
V8	130	80	---
V2	170	120	---
V7	220	170	---

6PC a 3PT

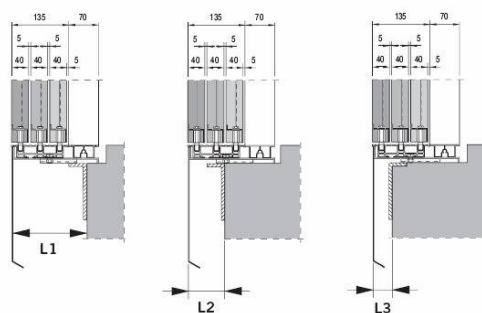

KONZOLE	ZPŮSOB UPEVNĚNÍ V ŠACHTĚ		
	L1	L2	L3
A	95	64	55
G	140	115	---
V8	130	120	---
V2	170	120	---
V7	220	170	---

8PC a 4PT

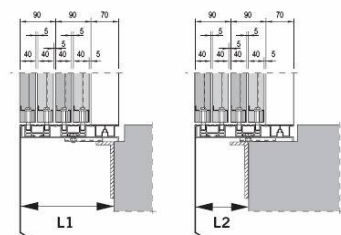

KONZOLE	ZPŮSOB UPEVNĚNÍ V ŠACHTĚ	
	L1	L2
A	95	64
G	140	115
V8	130	120
V2	170	120
V7	220	170