

SAFETY MODULE KB S  
GS ↓ ↑

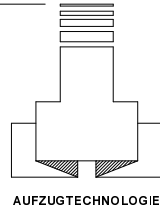

AUFZUGTECHNOLOGIE

PROGRESSIVE SAFETY GEAR KB 55 S ↓  
SAFETY GEAR EB 75 GS ↑  
= rated load + car weight in DOWN direction (FREE FALL)  
= 1/2 rated load + masses in UP direction  
Activated by overspeed governor through overspeed governor rope  
(standard finish with tension weight pit)

Drawing shows safety module  
RIGHT hand, LEFT hand opposite

IDLE POSITION

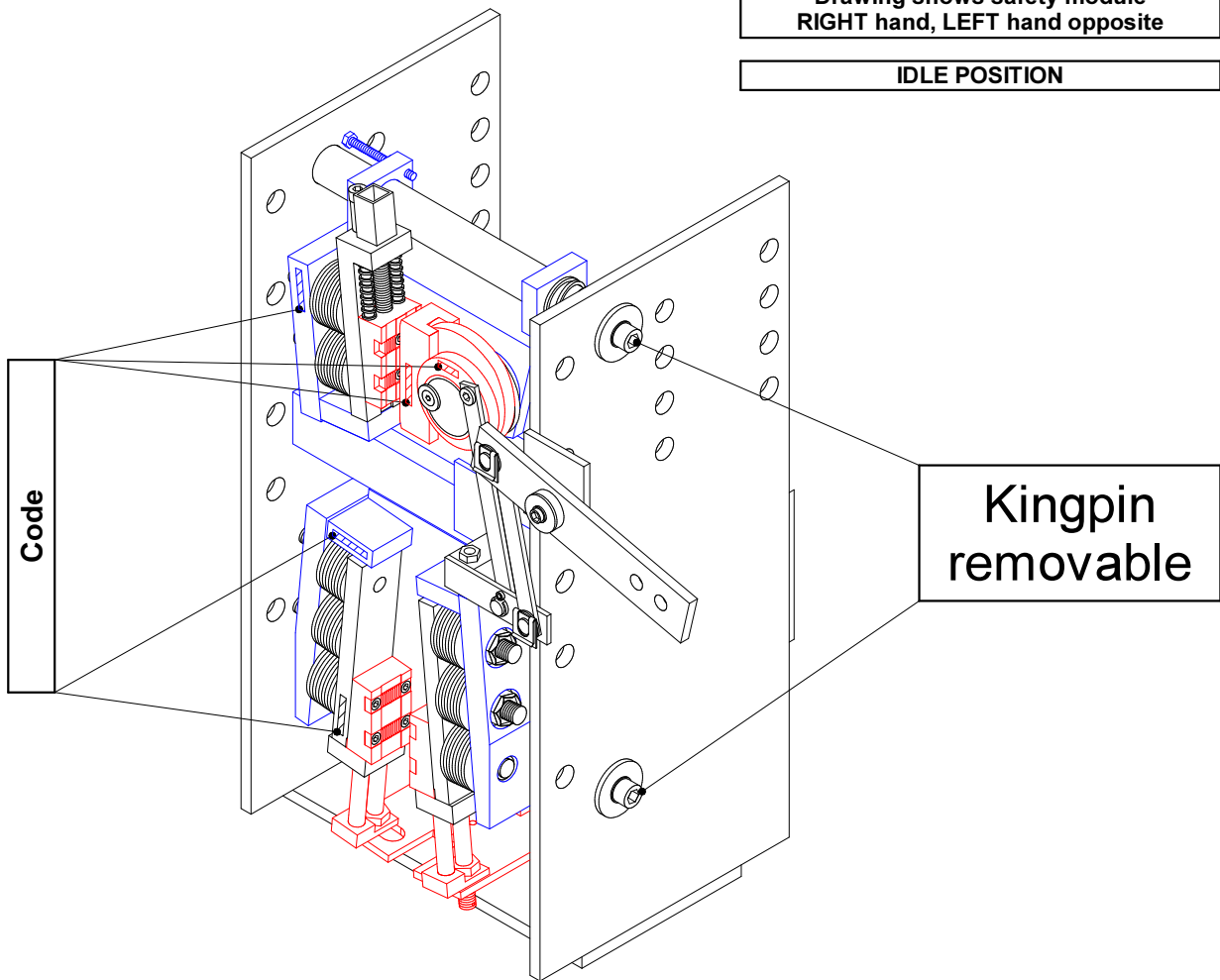

General Information	.....	5370.800.002
Nomination of parts and Outer housing	.....	5370.800.003
Installation and Maintenance	.....	5370.800.004
Adjustment on Site	.....	5370.800.005
Check	.....	5370.800.006
Safety Book - GENERAL - 1	.....	5360.800.007
Safety Book - GENERAL - 2	.....	5330.800.018
Safety Book - CHECKLIST	.....	5370.800.009
Safety Switch in Idle Position	.....	5230.800.018

**Construction - Function:**

SAFETY MODULE KB S GS ↓ ↑

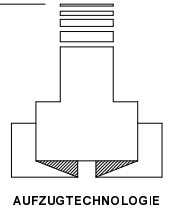

↑ EB 75 GS : The knurled eccentric pulls it self after actuating on. The disk washers will be tensioned. At the same time the bearing eccentric follows the bearing eccentric disk fitted to the safety gear block. An "overtaking" is due to kinetic reasons not possible.

↓ KB 55 S: The knurled tungsten wedge grip on the brake shoe pulls self-locking after engaging and tensions the spring washers.

Parameters: safety module ↓ ↑  
 guidethickness  
 guide rail surface  
 tripping speed  
 ↓ total mass  
 ↑ brake force

EB 75 GS	KB 55 S
accord. EEC type examination certificate ...	
ABV 289 / _	AFV 374 / _

Guide rail condition: machined, surface can be either dry or lubricated. Lubricant must be in accordance with DIN 51517, part 1.

The progressive safety gear ↓ KB 55 S and the safety gear ↑ EB 75 GS are certified to European Standards and hold certificates to DIN EN 81-1.

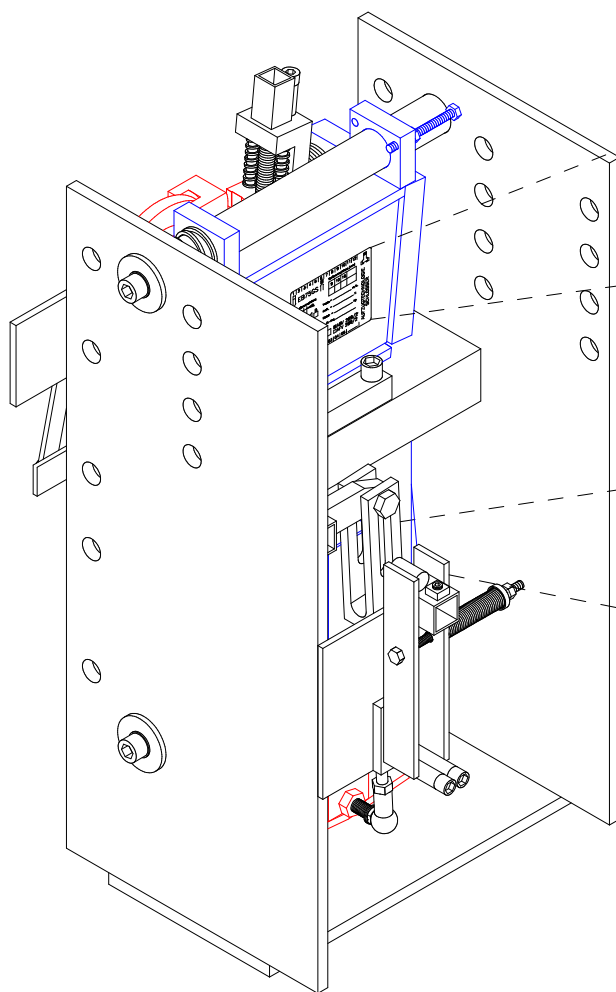

type: EB75GS month of supply: 9 | 10 | 16

Schienenkopfdicke [mm]: 9 | 10 | 16

Vauer = \_\_\_\_\_ m/s

Kraft ( ) = \_\_\_\_\_ N

Masse ( ) = \_\_\_\_\_ kg

Fabrik-Nr.: \_\_\_\_\_

CE 0635 ABV 289/2 AFV 289/2

1998 | 99 | 00 | 01 | 02 | 03 | 04 | 05

year of supply: \_\_\_\_\_ manufacturing plant identification: \_\_\_\_\_

type: KB55S month of supply: 9 | 10 | 16

Schienenkopfdicke [mm]: 9 | 10 | 16

Vauer = \_\_\_\_\_ m/s

Masse ( ) = \_\_\_\_\_ kg

Fabrik-Nr.: \_\_\_\_\_

CE 0635 AFV 374/1

1998 | 99 | 00 | 01 | 02 | 03 | 04 | 05

year of supply: \_\_\_\_\_ manufacturing plant identification: \_\_\_\_\_

**Warranty and guaranty:**

In case our product is not used for the application designed we can not take any responsibility whatsoever. It is the duty of the user to follow the local law and regulations under all circumstances.

Edition:  
16.07.2001



Manual ↓ KB 55 S - EB 75 GS ↑  
General Information

Drawing No.:  
5370.800.002

SAFETY MODULE

KB S  
GS

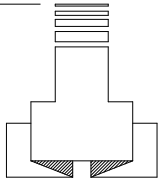

AUFZUGSTECHNOLOGIE

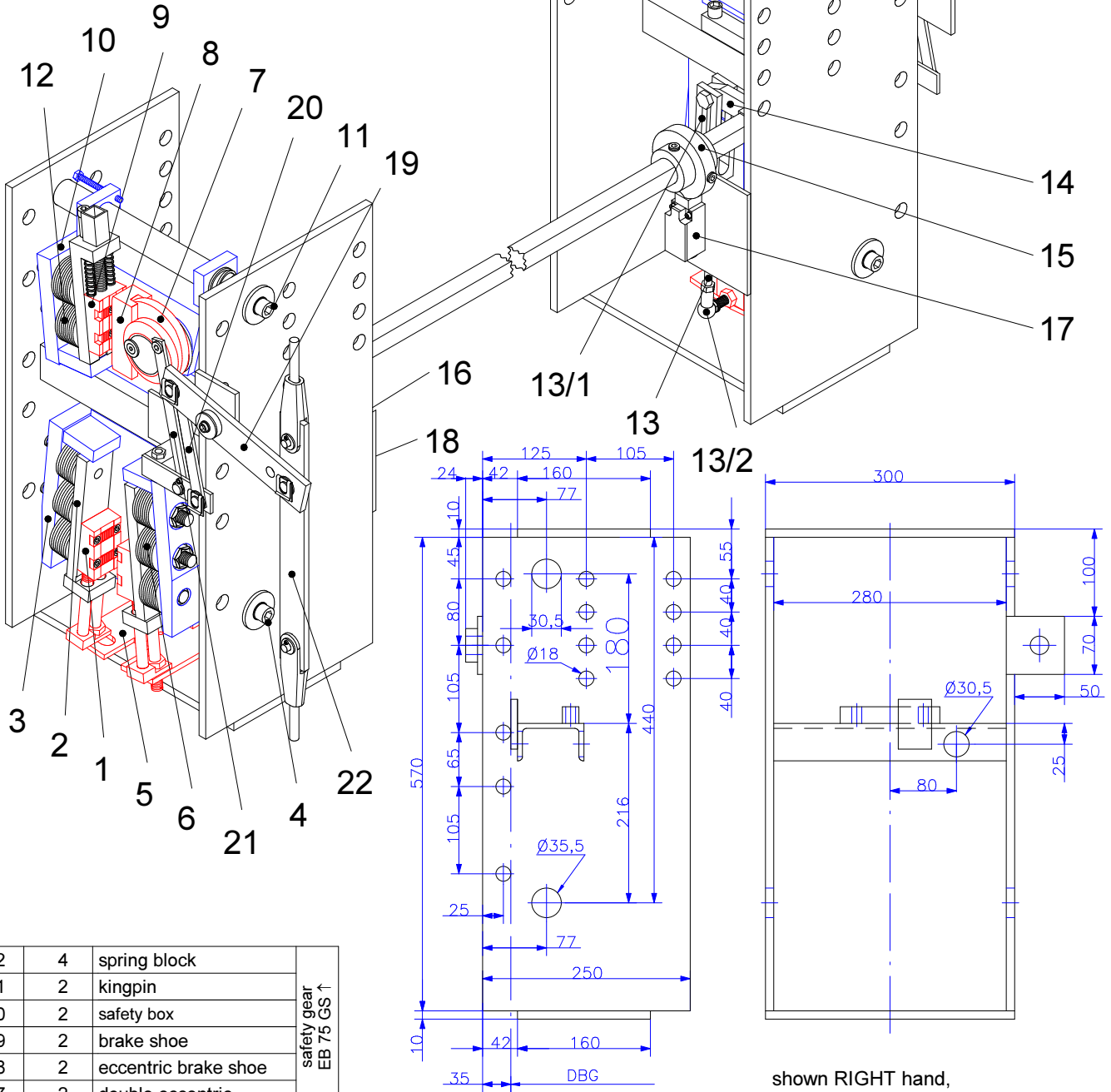

shown RIGHT hand,  
LEFT hand opposite

12	4	spring block	safety gear EB 75 GS ↑
11	2	kingpin	
10	2	safety box	
9	2	brake shoe	
8	2	eccentric brake shoe	
7	2	double eccentric	
6	6	spring block	progressive safety gear KB 55 S ↓
5	2	actuating sleeve	
4	2	kingpin	
3	2	safety housing	
2	4	brake shoe support	
1	4	wedge brake shoe	
Pos.	Qty.	Nomination of parts	

16	1	resetting unit	connecting rod and switch arrangement	22	1	rope coupling	connecting rod and switch arrangement
15	1	switching cam		21	2	tripping bar	
14	2	actuating lever		20	1	operating bar	
13/2	2	ball joint		19	1	operating lever	
13/1	2	free-wheel fork		18	1	free-wheel switch	
13	2	equalizer rod	17	1	safety switch		
Pos.	Qty.	Nomination of parts		Pos.	Qty.	Nomination of parts	

Edition:  
30.07.2002



Manual ↓ KB 55 S - EB 75 GS ↑  
Nomination of parts and Outer housing

Drawing No.:  
5370.800.003

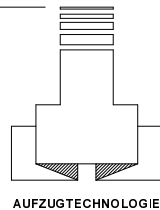

AUFZUGTECHNOLOGIE

SAFETY MODULE KB S GS ↓ ↑

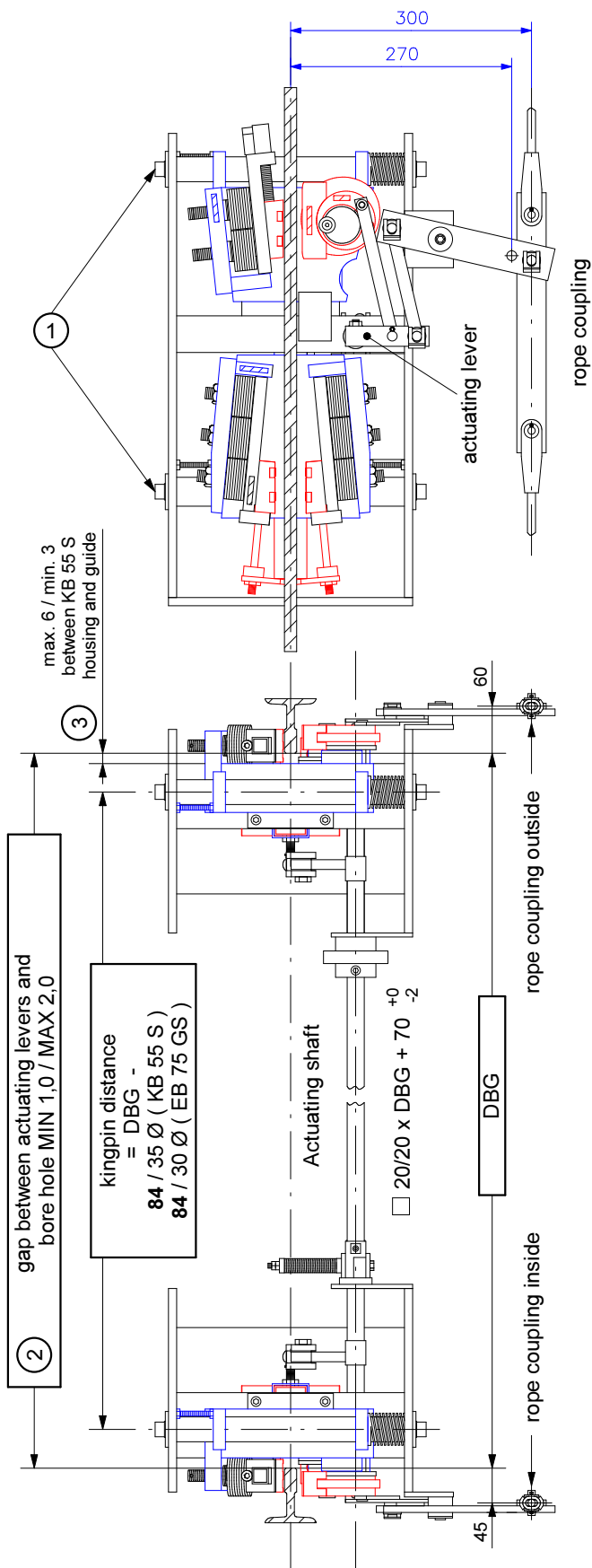

**(1) ATTENTION:** Safety gears are vital parts of a lift. They are manufactured to DIN ISO 9001 checked and finally packed to reach all criteria required. We strongly request that you check the label (documentation/delivery note) at your factory. All data must match with your order.

**(2)** Our safety gears are maintenance free. Please avoid rust arising from low temperatures and/or bad storage. Lubricate all moving parts especially steel tape on eccentric, eccentric axle, all bearings of the lever gear and actuating shaft.

**(3)** CLEAN safety gears are to be built in after guides have been CLEANED.

**(4)**

- ① THE KINGPINS MUST BE REMOVABLE. SO PLEASE TAKE CARE TO ALLOW THE NECESSARY SPACE.
- ② GAP BETWEEN ACTUATING LEVERS AND BORE-HOLE MUST BE ASSEMBLED BY DRILLING BORE-HOLE Ø 6,5 - 7,0 mm AND KEEPING AN ALLOWANCE OF 1 TO 2 mm.
- ③ SAFETY HOUSINGS KB 55 S MUST BE ADJUSTED TO THE GUIDE RAIL, LEAVE MAXIMUM 6 mm / MINIMUM 3 mm GAP.

**(5)** THE SITE ENGINEERS MUST NOTE THE FOLLOWING FOR MAINTENANCE ROUTINE:

- a) Square actuating shaft must be easily moveable by hand until one of the safety gear pairs enters the braking position.
- b) Braking either DOWN or UP direction: the actuating shaft must freely run back into original position when disengaging happens.
- c) Clean and properly maintained components are essential and guaranty a perfect function of our safety gears.
- d) Lubrication of guide rails only with recommended oils.



DEBRIS, DUST ETC. WILL NOT ALLOW A FREE DYNAMIC MOVEMENT !

Edition:  
30.07.2002



Manual ↓ KB 55 S - EB 75 GS ↑  
Installation and Maintenance

Drawing No.:  
5370.800.004

## FRONT SIDE

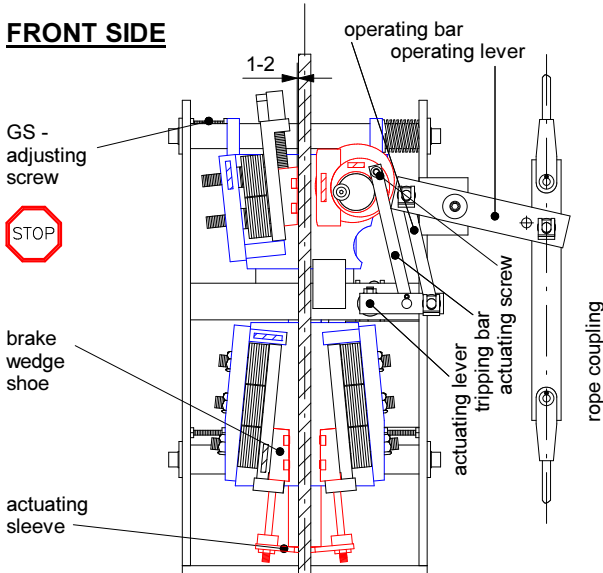

SAFETY MODULE

KB S  
GS

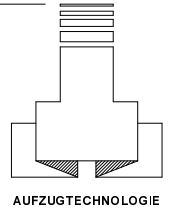

### Preliminary Note

We can not accomplish the pre-positioning in our works. Experienced site engineers must carry out the adjustment on site.

#### (1) Preparation

- Remove rope coupling from the operating lever
- Both actuating levers are fixed to the actuating rod, the complete backlash must be between 1 to 2 mm - axially
- Remove tripping bars to eccentric EB 75 KS ↑
- Remove both safety switches and the resetting spring
- Remove both ball joints to actuating sleeves  
→ EASY RUNNING OF THE ACTUATING SHAFT FOR SURE ! ←
- Jam tightly the back setter in the right position
- Put in and prestress lightly resetting spring with the freewheel forks
- Jam tightly both actuating levers in the right position
- Open sideways adjustments of all safety gears - turn adjusting screws = 4 x KB 55 ↓ and 2 x EB 75 KS ↑ - anticlockwise into the housings

## BACKSIDE

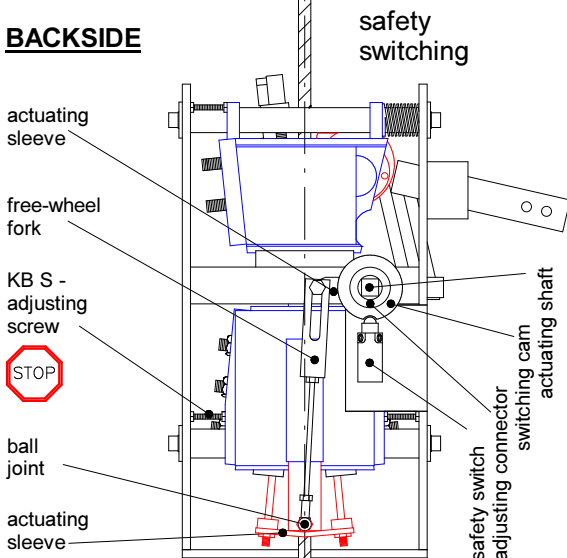

#### (2) Adjustment of KB 55 S ↓ for synchronous operation

- Push the actuating sleeves in UP direction, if not possible by hand use the hammer (with care !) and fix it = BRAKING START
- All 4 adjusting screws of the KB 55 S ↓ clockwise to be turned out onto the housing up to a gap of 1 mm, but observe: the screw head must not touch the housing - in no case
- Shortly run up the car until the actuating sleeves run down in this down position = OFF POSITION place the ball joints equally by means of the equalizer rod, press them in and secure them
- But decidingly is the equal position of the wedge brake shoes on BRAKING START: i.e. push up the operating lever until the actuating shaft press the wedge brake shoes onto the guide rails = BRAKING START - now either are equal position or you have to readjust again by means of the equalizer rod. A small forerun of the wedge brake shoes opposite the operation levers is advantageous.
- Turn back the actuating shaft, the actuating sleeves are down too = OFF POSITION !

## BACKSIDE

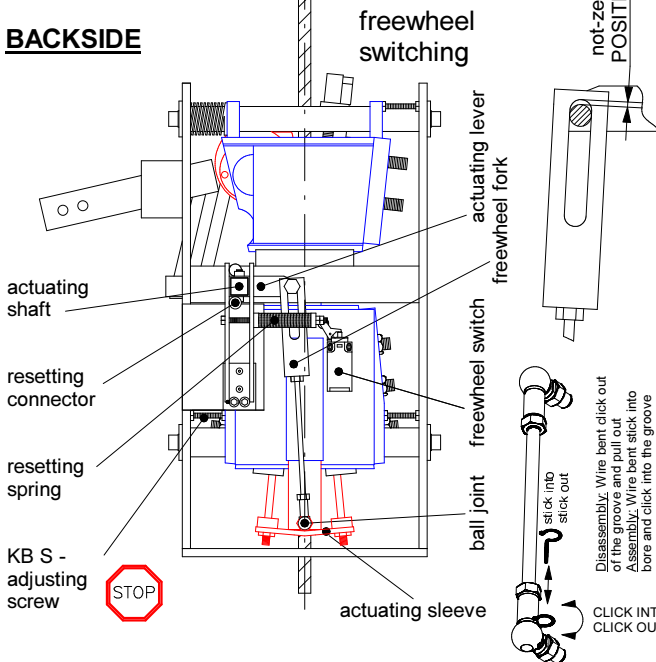

#### (3) Adjustment of EB 75 GS ↑

- Turn KS-adjusting screws to get a gap of 1-2 mm to the guide rail and tighten the bolt by means of a lock nut.
- Rope coupling and double eccentric must be connected by the actuating screw.

#### (4) MAKE SURE THAT ALL PARTS ARE MOVING FREE AND SECURE ALL PARTS !

#### (5) Check with connected shaft actuating sleeves

- The adjustment of the actuating force is the result of the pre-tension of the return spring.
- The actuating force in UP direction must not exceed 150 N in either direction.
- Test in ↑ direction must be carried out with empty car.
- Test in ↓ direction with empty car; due to the "JUMPING" of the counter weight are unequal positions of the wedge brake shoes possible.
- Both switches + switching cam to be adjusted and fixed.

#### (6) Final inspection

- Even with empty car and low speed the marks on the guide rails must be equally.
- The safety gears must set back into the OFF-POSITION by themselves.

Please refer also to our brochure with photographs !



DEBRIS, DUST ETC. WILL

NOT ALLOW A FREE DYNAMIC MOVEMENT !

Edition:  
30.07.2002



Manual ↓ KB 55 S - EB 75 GS ↑  
Adjustment on Site

Drawing No.:  
5370.800.005



**TEST:** PROGRESSIVE SAFETY GEAR ↓  
SAFETY GEAR ↑

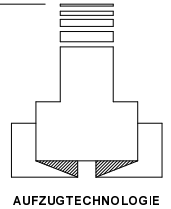

The friction depends on several factors like hardness of the guide rail surface, roughness and the surface hardness of the brake shoes of the safety gear unit. The brake force is also vital. The brake force depends on the adjusted end point of the selected springs. The friction coefficient is the result of:

- a) Material and form of the brake shoes
- b) -> Hardness and roughness of the guide rails  
-> Type and viscosity of the lubrication oil

Experienced lift engineers will before starting the installation drive check the installed car sling. The actuating, braking distance, and engaging should be checked before hand. During this test the overspeed governor will be checked as well.



WE ARE PLEASED TO HAND OVER THE SPRING LOAD CHARACTERISTICS CURVES AND ADJUST- AND RE-ADJUST INSTRUCTIONS TO LIFT ENGINEERS WILLING TO ACCEPT RESPONSIBILITY.

reading of marks



**DOWN direction KB 55 S**

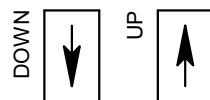

Vor der Inbetriebnahme des Aufzuges ist unbedingt eine Fangprobe durchzuführen.

- a) Load 1,25 times contract load, run lift, open brake manually, DO NOT LOOP progressive safety gear and overspeed governor and actuate the progressive safety gear.
- b) Contract load, run lift, open brake manually, main circuit breaker "OFF", lift will engage overspeed governor and actuate progressive safety gear.

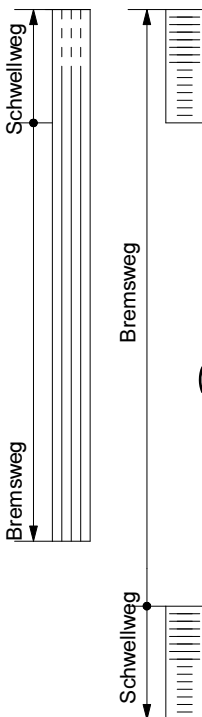

**UP direction - EB 75 GS**



- a) In UP direction without any load, open brake manually, main circuit breaker "OFF", lift will engage overspeed governor and actuate safety gear.
- b) -> If the load is small, travel height low or the efficiency of the drive system is poor you may not reach the tripping speed.  
-> In this case you must run the lift mechanically in UP direction and engage the overspeed governor manually - switch off the main circuit breaker immediately.



**CANCEL THE BRAKE POSITION: FAST PASSING**

Depending on site condition you may test the lift several times to assure that under all conditions the system is working perfect. The principle is main ropes under tension - main ropes slack. In case you can not get the car out of the safety gear a traction sheave clamp is useful. Also with the assistance of the hand winding procedure it will ease the car.

In the **DOWN direction** and actuated progressive safety gear most of the energy is already destroyed during reaching the threshold value.

In the **UP direction** is due to the soft actuating and a long threshold distance the energy low.

$$\text{deceleration [g]: } a = \frac{v^2}{2 * s * 10} = \frac{[ \quad ]^2}{2 * [ \quad ] * 10}$$

v = deceleration start speed [m/s]; s = deceleration distance [m]; a = deceleration [g];



DEBRIS, DUST ETC. WILL NOT ALLOW A FREE DYNAMIC MOVEMENT !

Edition:  
16.07.2001



Manual ↓ KB 55 S - EB 75 GS ↑  
Check

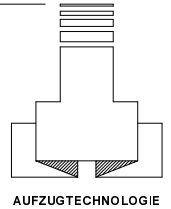

Drawing No.:  
5370.800.006







## WHY ARE YOU NOT MAKING YOUR LIFE EASIER !

Working with lifts needs a sense of responsibility and is also sometimes hard physical work. You can take a lot of the strain from your site engineers by following our suggestion based on our long experience in the field.

### (a) KEEP ALWAYS AMPLE ROOM AROUND ALL CONSTRUCTION PARTS OF THE CAR SLING AND SAFETY GEAR COMPONENTS:



-  The main carrier bolt must be easily removed.
-  Keep easy access for works on the safety gear.
-  Keep sufficient room at the car framework to check actuating gear and safety switch and each part.

### (b) Make sure free and easy running:

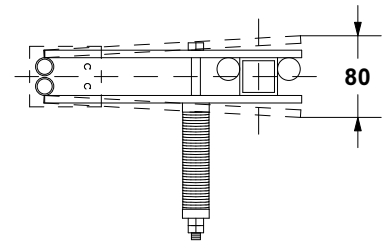
-  At detached actuating bars to cam eccentric discs, unscrewed safety switch and free resetting spring the actuating shaft be turned around free and easily.
-  At turning the freed cam eccentric discs no obstacle is to be felt.
-  At fixed actuating bars the actuating shaft can be turned up to contacting the cam eccentric disc with the guide rail.
-  At stressed resetting spring and safety switch screwed on the pulling force on the governor rope may not surpass 300 N in DOWN direction and 150 N in UP direction.



### (c) DO NOT USE HEAVY OVERSPEED GOVERNOR ROPE TENSION WEIGHT:

-  Our tension weight DrawingNo. 5230.260.300 is tailor made for our units.
-  Tension weight exceeding 60 kg demolishes the actuating shaft components and complicated the release of the safety gear blocks.

### (d) CHECK ALL THE COMPONENTS IN ACCORDANCE TO EN 81.

### (e) READ OUR INSTRUCTION MANUAL CAREFULLY.

### (f) THE SAFETY MODULE SAFETY GEAR ASCENDING SAFETY ↓↑ IS THE SIGNIFICANT PART OF THE LIFT CONSTRUCTION. HENCE MAKE ABSOLUTELY SURE EVERY CARE IS TAKEN TO INSTALL THE COMPONENTS CORRECT.

-  DEBRIS, DUST ETC. WILL NOT ALLOW A FREE DYNAMIC MOVEMENT !

## Annex D

SAFETY MODULE

SAFETY GEAR  
ASCENDING SAFETY

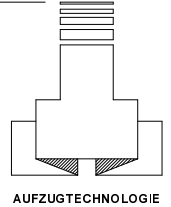

AUFZUGTECHNOLOGIE

### D.2 Tests and verifications

·  
·  
·  
j) car safety gear (9.8):

the energy which the safety gear is capable of absorbing at the moment of engagement will have been verified in accordance with F.3. The aim of the test before putting into service is to check the correct mounting, correct setting and the soundness of the complete assembly, comprising car, safety gear, guide rails and their fixing to the building.

The test shall be made while the car is descending, with the required load uniformly distributed over the car area, with the machine running until the ropes slip or become slack, and under the following conditions:

·  
·

2. progressive safety gear:

the car shall be loaded with 125 % of the rated load, and travel at rated speed or lower.

When the test is made with lower than rated speed, the manufacturer shall provide curves to illustrate the behaviour of the type tested progressive safety gear when dynamically tested with the suspensions attached.

After the test, it shall be ascertained that no deterioration, which could adversely affect the normal use of the lift has occurred. If necessary, friction components may be replaced. Visual check is considered to be sufficient.

Note:

In order to facilitate disengagement of the safety gear, it is recommended that the test be carried out opposite a door in order to be able to unload the car.

·  
·

n) ascending car overspeed protection means (9.10):

the test shall be made while the empty car is ascending at not less than rated speed, using only this device for braking.

Edition:  
16.07.2001



Safety Book - GENERAL - 2  
Extract from European Standard prEN 81-1

Drawing No.:  
5330.800.018



SAFETY MODULE

KB S ↓  
GS ↑

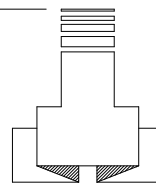

AUFZUGTECHNOLOGIE

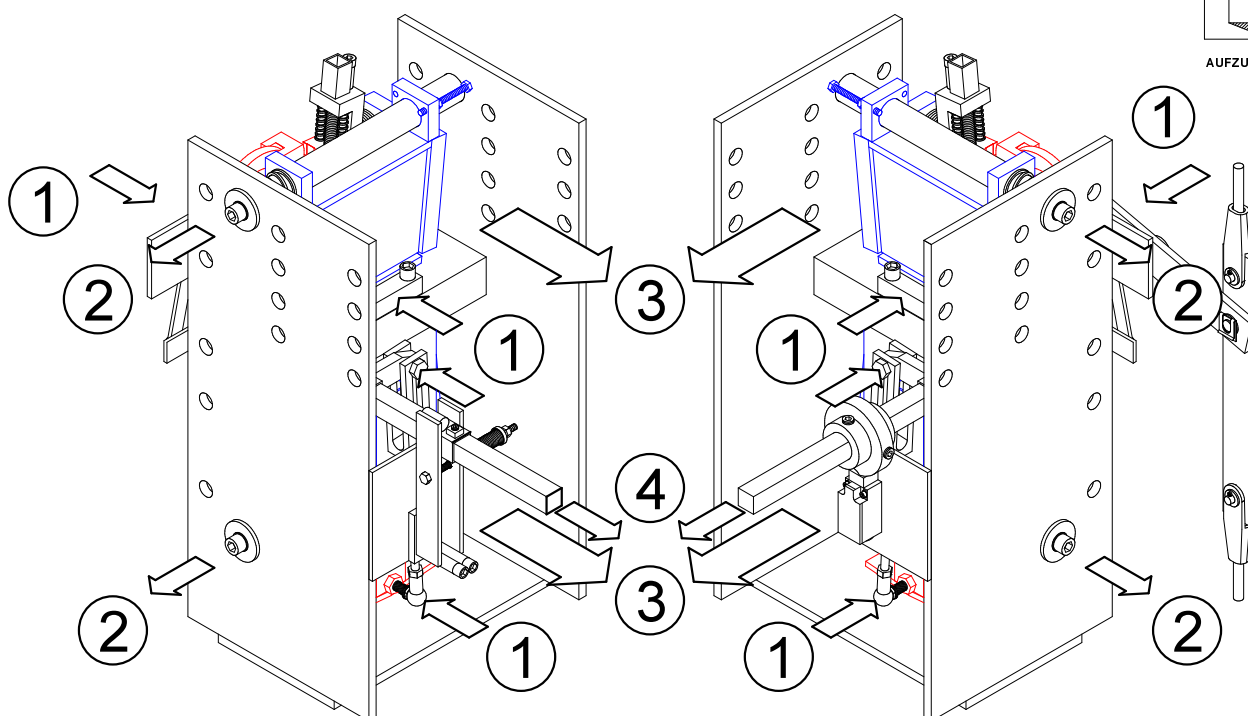

#### **ATTENTION:** DISMANTLING

- ① unscrew all related parts and fixings of KB 55 S ↓ and EB 75 GS ↑ - remove safety switch
- ② unscrew the fixings and remove the kingpins
- ③ the complete units KB 55 S ↓ and EB 75 GS ↑ must be without taking any parts from the car sling removable

#### **ATTENTION:** ACTUATING SHAFT

- ④ actuating shaft with gap 1-2 mm (axial), movable by hand

#### **ATTENTION:** ASSEMBLING

Only clean guide rails and brake shoe surface will give you the full performance - don't put the safety gear units in before you checked this.

- we tested paint thinner "LUSIN 400"
- otherwise: Cold Cleaner  
Dieseloil  
Rust Preventive
- Follow the recommendations of the guide rail suppliers !

#### **ATTENTION:** TAKE CARE TO USE JUST APPROPRIATE LUBRICANTS !

Edition:  
16.07.2001



Safety Book - CHECKLIST  
Safety Module ↓ KB 55 S - EB 75 GS ↑

Drawing No.:  
5370.800.009

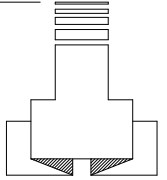

AUFZUGTECHNOLOGIE

**Safety Switch - IDLE POSITION**  
**Safety Module (↑↓)**

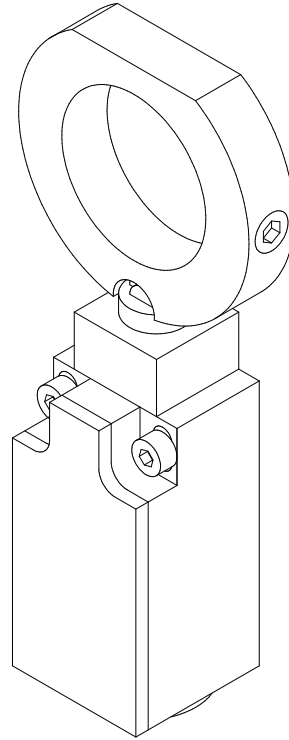
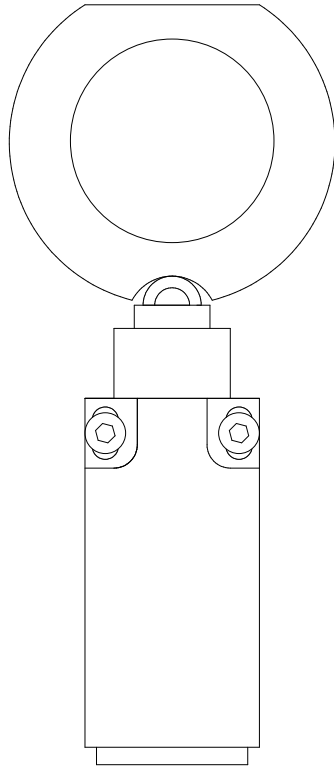

**Safety Switch - IDLE POSITION**  
**Safety Gear (↓)**

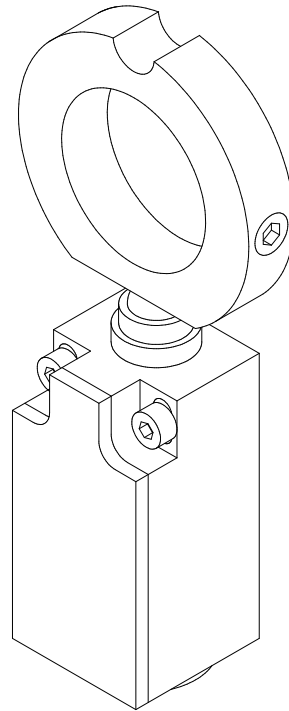
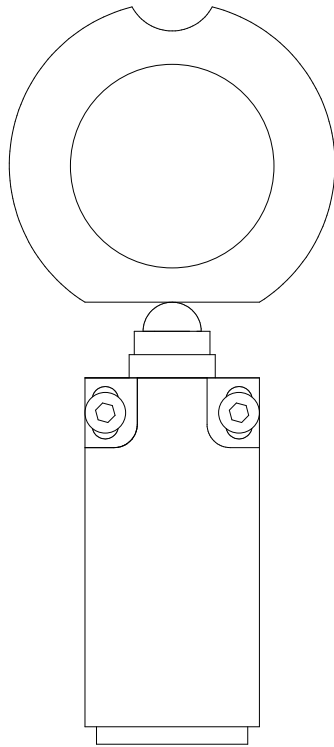

Edition:  
16.07.2001



**SAFETY SWITCH in IDLE POSITION**

Drawing No.:  
**5230.800.018**